

# OPEN

TWO PEOPLE MUST OPEN AND CLOSE TABLE TO AVOID INJURY

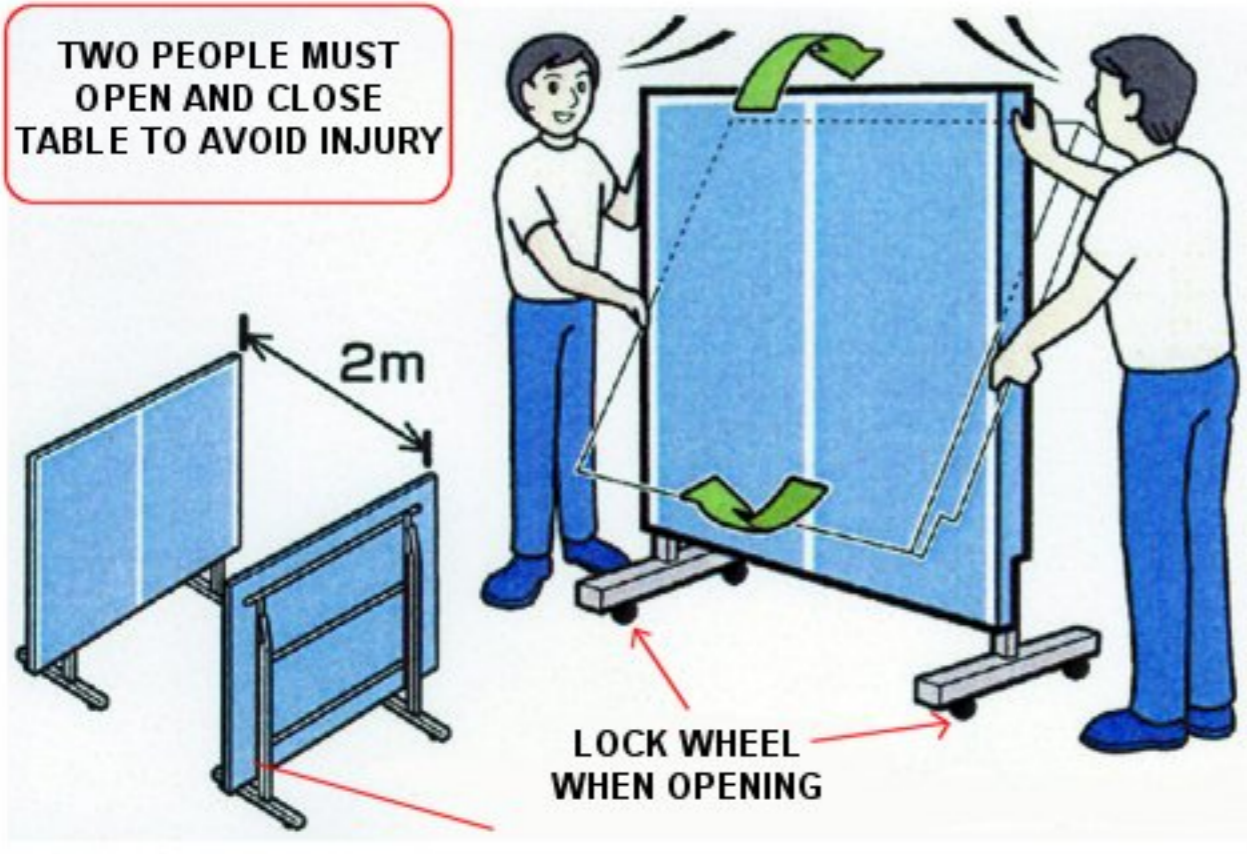

BE SURE TO RELEASE CATCH BEFORE OPENING

# CLOSE



ENSURE YOU HEAR A CLICK AS THE CATCH LOCKS THE TABLE WHEN IT IS FULLY CLOSED

# MOVE



Be sure the wheels are unlocked.

# SAVE

## NOTICE



Avoid the sunshine and rain. This table is for indoor use only.

## CAUTION

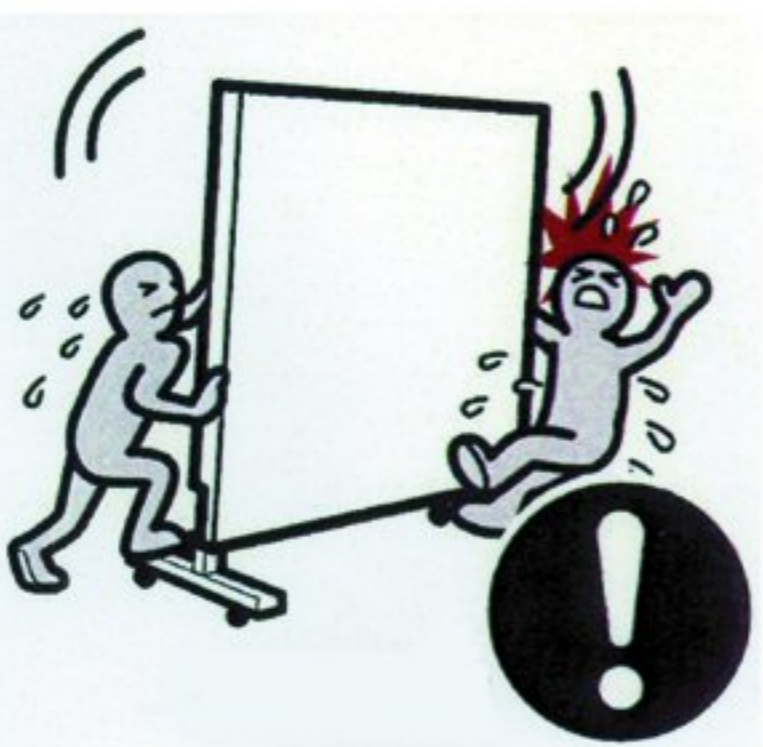

Handle with care during transit, set-up and breakdown.







Be careful not to catch your fingers between the tabletops and connections.

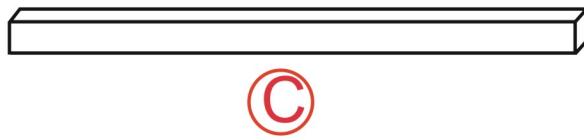
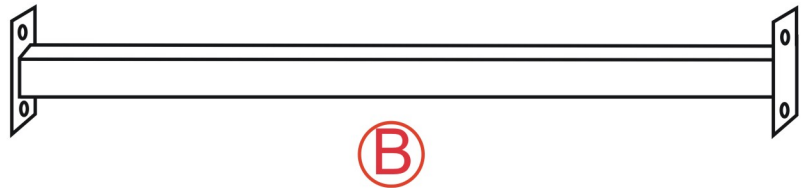
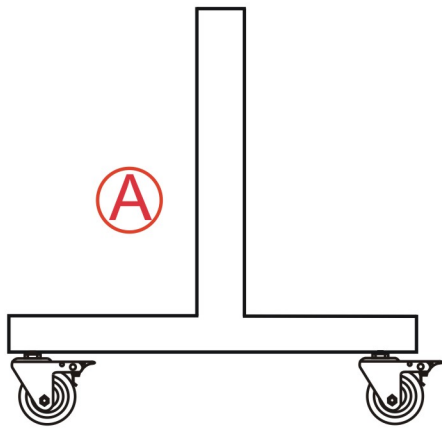
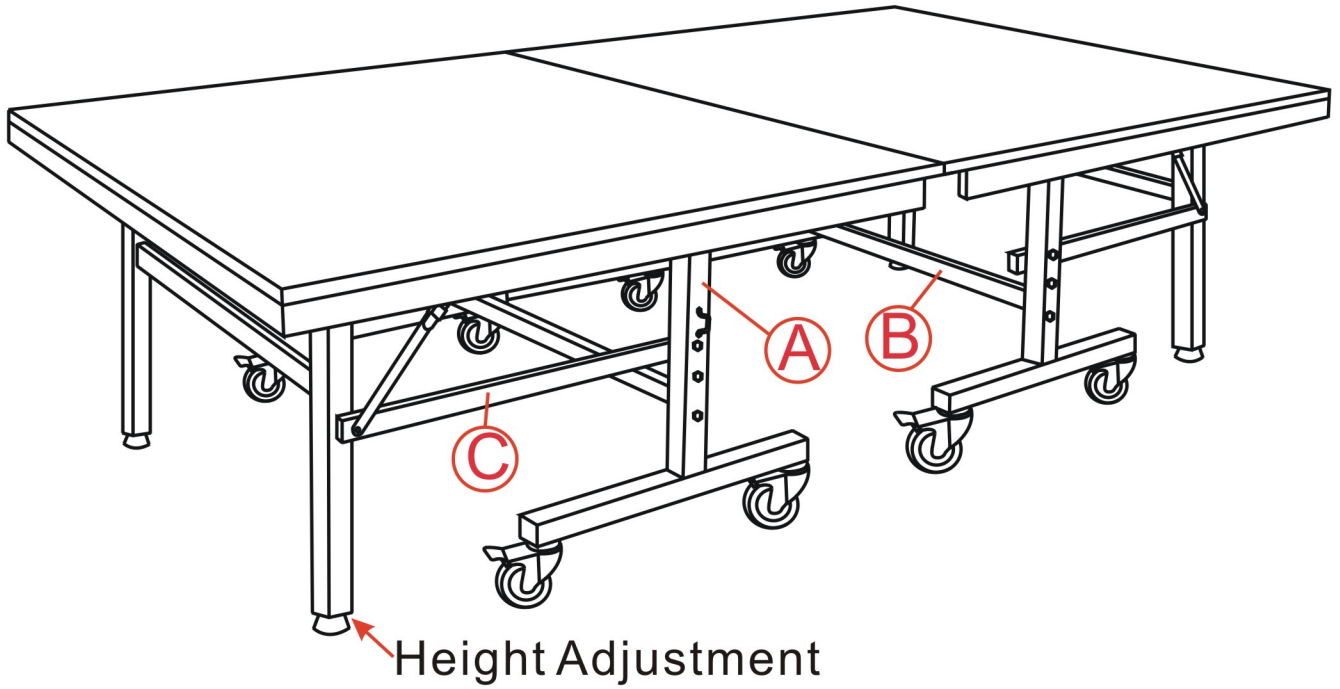

Do not lean on, sit on, or crawl under the table.

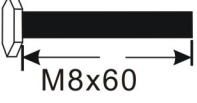
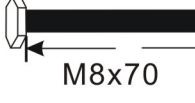
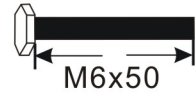
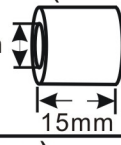
# MODEL: LION SCHOOL 25 SPORT/LION 25 SPORT ASSEMBLY INSTRUCTIONS

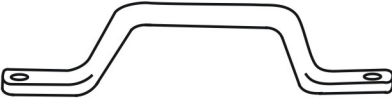

<b>Bolt #1 (12 Pcs.)</b>  M8x60	<b>Bolt #2 (4 Pcs.)</b>  M8x70	<b>Bolt #3 (4 Pcs.)</b>  M6x50	<b>Spacers (4 Pcs.)</b>  8mm 15mm	<b>Nuts #1 (16 Pcs.)</b>  8mm
<b>Nuts #2 (4 Pcs.)</b>  6mm	<b>Nuts #3 (4 Pcs.)</b>  12mm	<b>Locking Bracket (2 Pcs.)</b> 		

# MODEL: LION SCHOOL 25 SPORT/LION 25 SPORT ASSEMBLY INSTRUCTIONS IMPORTANT

LEAVE TABLE TOP IN CARTON DURING ASSEMBLY.  
ENSURE TABLE CARTON IS PLACED FLAT DOWN ON A SMOOTH  
DUST FREE LEVEL SURFACE OTHERWISE THE TOP  
WILL BE SCRATCHED.

